

**BASIL**

Basil is a broad offering of flexible, modular seating that offers design solutions for any interior space. Straight pieces and curvilinear shapes allow designers to create forms of seating and tables that flow and support the architectural design of spaces. Optional wood and metal arms, metal legs, and numerous table designs support the product's design and its users. Built-in clean-out spaces and polyurethane arm caps make Basil equally durable in high traffic areas.

**TYPICALS**

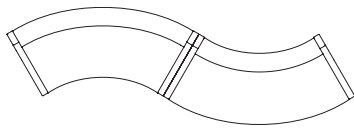

(One) 60 Inside Wedge Loveseat  
(One) 60 Outside Wedge Loveseat

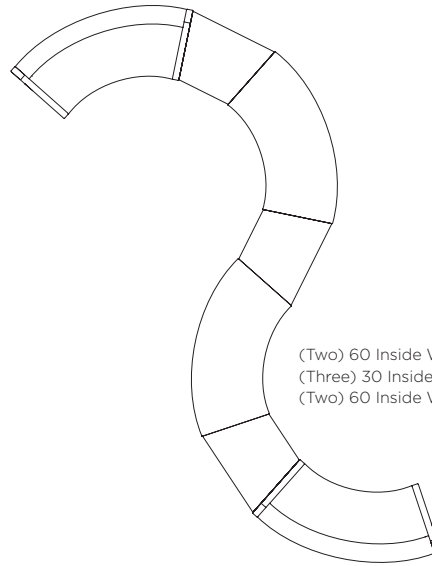

(Two) 60 Inside Wedge Loveseats  
(Three) 30 Inside Wedge Tables  
(Two) 60 Inside Wedge Benches

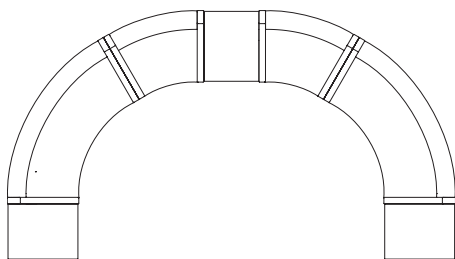

(Two) End Tables  
(Two) 60 Inside Wedge Loveseats  
(Two) 30 Inside Wedge Chairs  
(One) M Table

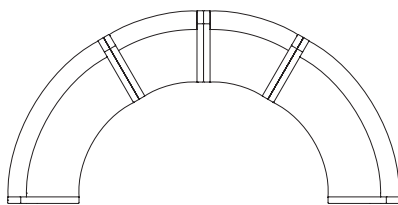

(Two) 60 Inside Wedge Loveseats  
(Two) 30 Inside Wedge Chairs

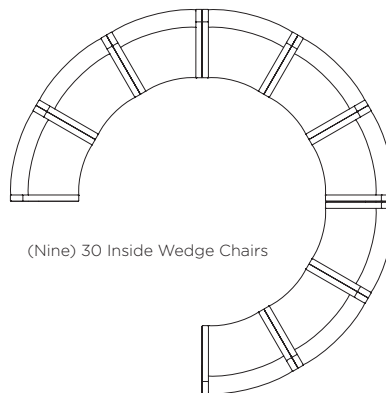

(Nine) 30 Inside Wedge Chairs

**ORDERING EXAMPLE:**

- Specify:
- Quantity
- Product by Number
- Arms and Arm Caps
- Leg
- Wood Finish (if applicable)
- Seat Back
- Fabric 1 Grade, Vendor, Pattern and Color

MODEL NUMBER					
5110-1					
Metal Arms	Wood Arms and Arm Caps	Leg	Finish	Seat Back	Fabric 1
X9	EIZ - A4	A4	MNW	L4	Momentum, Row, Breeze

To ensure accuracy please provide Customer Service with a diagram of your specific configuration requirements at time of order.

**BASIL LOUNGE MODULAR STANDARD FEATURES**

- Armless
- Clean-Thru Design
- Upholstered Seat, Back and Sides on 5110-1 and 5110-2
- Upholstered Seat and Sides on 5110-B42
- Tight Cushion
- European Beech Legs
- Euroluxe® with SilverBan® on all Exposed Wood Surfaces
- Non-Marring Adjustable Glides
- Ganging Devices
- NOTE: Floor Plan Required for any Ganging Configurations

**CHAIR**

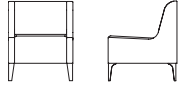

w	outside d	h	sw	seat sd	sh	seat to top of back	arm height	weight lbs.	cubic feet
26	27.5	32	21	20	18	14	n/a	60	27

model	yds com (54")	sq ft col	com 1	col 2	3	4	5	6	7	8	9	10	11	12	13	14	15	L1	L2	L3
5110-1	4	n/a	1,455	1,530	1,587	1,681	1,869	2,057	2,245	2,433	2,621	2,809	2,997	3,185	3,374	3,562	3,750	2,079	2,299	2,572

**LOVESEAT**

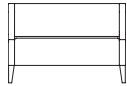

w	outside d	h	sw	seat sd	sh	seat to top of back	arm height	weight lbs.	cubic feet
47	27.5	32	42	20	18	14	n/a	90	40

model	yds com (54")	sq ft col	com 1	col 2	3	4	5	6	7	8	9	10	11	12	13	14	15	L1	L2	L3
5110-2	5	n/a	1,858	1,952	2,023	2,140	2,375	2,610	2,845	3,081	3,316	3,551	3,786	4,021	4,256	4,491	4,726	2,631	2,906	3,247

**STRAIGHT BENCH**

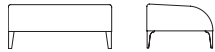

w	outside d	h	sw	seat sd	sh	seat to top of back	arm height	weight lbs.	cubic feet
42	27.5	18	n/a	n/a	n/a	n/a	n/a	75	21

model	yds com (54")	sq ft col	com 1	col 2	3	4	5	6	7	8	9	10	11	12	13	14	15	L1	L2	L3
5110-B42	2.25	n/a	1,014	1,056	1,088	1,141	1,247	1,353	1,458	1,564	1,670	1,776	1,882	1,987	2,093	2,199	2,305	1,377	1,501	1,654

**BASIL METAL AND WOOD ARM STANDARD FEATURES**

- Not available on Basil Bench Seating
- Brushed Aluminum Finish on Metal Arms
- Poly Arm Caps included on Metal Arm
- European Beech Wood Arm
- Poly Arm Cap must be specified for Wood Arm
- Euroluxe® with SilverBan® on all Exposed Wood Surfaces

**ARM**



w	outside d	h	sw	seat sd	sh	seat to top of back	arm height	weight lbs.	cubic feet
2.25	21.25	8.75	n/a	n/a	n/a	n/a	25.25	10	n/a

**OPTIONS**

Metal Arms	Wood Arms and Arm Caps	Leg	Arm/Leg Finish (if applicable)	Seat Back	Fabric 1
<b>Standard X9</b> No Selection of Option	<b>Standard X9</b> No Selection of Option	<b>Standard C8</b> Wood Leg	<b>Selection Required</b> For EIZ, FIA, FIB and C8 Options	<b>Standard X9</b> No Selection of Option	<b>Selection Required</b>
With Black Poly Arm Cap <b>E1W</b> Left Side Facing \$283 <b>E1X</b> Right Side Facing \$283 <b>E1Y</b> Pair of Arms, Left and Right \$566	Wood (specify finish) <b>E1Z</b> Left Side Facing \$191 <b>F1A</b> Right Side Facing \$191 <b>F1B</b> Pair of Arms, Left and Right \$382  Arm Caps <b>A4</b> Poly (black) \$102 each	<b>D1E</b> Brushed Aluminum Metal Leg	See page 9 for full list of finish options	<b>L4</b> Back Bump Guard \$178	Fabric: Grade, Vendor, Pattern, Color  NOTE: For multiple fabric applications see page 14 for information and pricing

**HOW TO ORDER**

SPECIFY: Arms and arm caps | legs | wood finish (if applicable) | seat back | textile pattern and color. See pages 5-14 for information and options on moisture barrier, CAL133, upholstery applications, a complete offering of finishes and ordering details.

MODEL NUMBER					
Metal Arms	Wood Arms and Arm Caps	Leg	Arm/Leg Finish (if applicable)	Seat Back	Fabric 1
X9	E1Z - A4	C8	MNW	L4	Grade 5, Momentum, Row, Breeze

**BASIL LOUNGE MODULAR STANDARD FEATURES**

- Armless
- Clean-Thru Design
- Upholstered Seat, Back and Sides
- Tight Cushion
- European Beech Legs
- Ganging Devices
- Euroluxe® with SilverBan® on all Exposed Wood Surfaces
- Non-Marring Adjustable Glides
- NOTE: Floor Plan Required for any Ganging Configurations

**30° INSIDE WEDGE CHAIR**

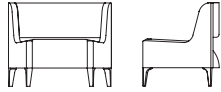

w	outside			sw	seat			seat to top of back	arm height	weight lbs.	cubic feet
	d	h			sd	sh					
39.5	29	32		23	20	18		14	n/a	62	38

model	yds com (54")	sq ft col	com 1	col 2	3	4	5	6	7	8	9	10	11	12	13	14	15	L1	L2	L3
5110-30I	4.75	n/a	1,801	1,890	1,957	2,069	2,292	2,516	2,739	2,962	3,186	3,409	3,633	3,856	4,079	4,303	4,526	2,537	2,798	3,122

**30° OUTSIDE WEDGE CHAIR**

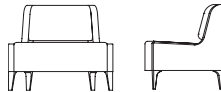

w	outside			sw	seat			seat to top of back	arm height	weight lbs.	cubic feet
	d	h			sd	sh					
39.5	29	32		23	20	18		14	n/a	62	38

model	yds com (54")	sq ft col	com 1	col 2	3	4	5	6	7	8	9	10	11	12	13	14	15	L1	L2	L3
5110-30O	4.75	n/a	1,801	1,890	1,957	2,069	2,292	2,516	2,739	2,962	3,186	3,409	3,633	3,856	4,079	4,303	4,526	2,537	2,798	3,122

**BASIL METAL AND WOOD ARM STANDARD FEATURES**

- Not available on Basil Bench Seating
- Brushed Aluminum Finish on Metal Arms
- Poly Arm Caps included on Metal Arm
- European Beech Wood Arm
- Poly Arm Cap must be specified for Wood Arm
- Euroluxe® with SilverBan® on all Exposed Wood Surfaces

**ARM**



w	outside			sw	seat			seat to top of back	arm height	weight lbs.	cubic feet
	d	h			sd	sh					
2.25	21.25	8.75		n/a	n/a	n/a		n/a	25.25	10	n/a

**OPTIONS**

Metal Arms	Wood Arms and Arm Caps	Leg	Arm/Leg Finish (if applicable)	Seat Back	Fabric 1
<b>Standard X9</b> No Selection of Option	<b>Standard X9</b> No Selection of Option	<b>Standard C8</b> Wood Leg	<b>Selection Required</b> For EIZ, FIA, FIB and C8 Options	<b>Standard X9</b> No Selection of Option	<b>Selection Required</b>
With Black Poly Arm Cap <b>EIW</b> Left Side Facing \$283 <b>EIX</b> Right Side Facing \$283 <b>EIY</b> Pair of Arms, Left and Right \$566	Wood (specify finish) <b>EIZ</b> Left Side Facing \$191 <b>FIA</b> Right Side Facing \$191 <b>FIB</b> Pair of Arms, Left and Right \$382  Arm Caps <b>A4</b> Poly (black) \$102 each	<b>DIE</b> Brushed Aluminum Metal Leg	See page 9 for full list of finish options	<b>L4</b> Back Bump Guard \$178	Fabric: Grade, Vendor, Pattern, Color  NOTE: For multiple fabric applications see page 14 for information and pricing

**HOW TO ORDER**

SPECIFY: Arms and arm caps | legs | wood finish (if applicable) | seat back | textile pattern and color. See pages 5-14 for information and options on moisture barrier, CAL133, upholstery applications, a complete offering of finishes and ordering details.

**MODEL NUMBER**

5110-30I

Metal Arms	Wood Arms and Arm Caps	Leg	Arm/Leg Finish (if applicable)	Seat Back	Fabric 1
X9	EIZ - A4	C8	MNW	L4	Grade 5, Momentum, Row, Breeze

**BASIL LOUNGE MODULAR STANDARD FEATURES**

- Armless
- Clean-Thru Design
- Upholstered Seat, Back and Sides
- Double Top Stitch in Center of Seat and Back
- Tight Cushion
- European Beech Legs
- Ganging Devices
- Euroluxe® with SilverBan® on all Exposed Wood Surfaces
- Non-Marring Adjustable Glides
- NOTE: Floor Plan Required for any Ganging Configurations

**60° INSIDE WEDGE LOVESEAT**

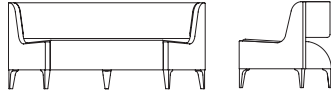

w	outside d	h	sw	seat sd	sh	seat to top of back	arm height	weight lbs.	cubic feet
73	33.75	32	42	20	18	14	n/a	95	80

model	yds com (54")	sq ft col	com 1	col 2	3	4	5	6	7	8	9	10	11	12	13	14	15	L1	L2	L3
5110-60I	7.25	n/a	2,723	2,859	2,962	3,132	3,473	3,814	4,155	4,496	4,837	5,178	5,519	5,859	6,200	6,541	6,882	3,832	4,230	4,725

**60° OUTSIDE WEDGE LOVESEAT**

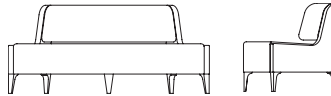

w	outside d	h	sw	seat sd	sh	seat to top of back	arm height	weight lbs.	cubic feet
73	33.75	32	42	20	18	14	n/a	95	80

model	yds com (54")	sq ft col	com 1	col 2	3	4	5	6	7	8	9	10	11	12	13	14	15	L1	L2	L3
5110-60O	7.25	n/a	2,737	2,873	2,976	3,146	3,487	3,828	4,169	4,510	4,851	5,192	5,533	5,873	6,214	6,555	6,896	3,846	4,244	4,739

**BASIL METAL AND WOOD ARM STANDARD FEATURES**

- Not available on Basil Bench Seating
- Brushed Aluminum Finish on Metal Arms
- Poly Arm Caps included on Metal Arm
- European Beech Wood Arm
- Poly Arm Cap must be specified for Wood Arm
- Euroluxe® with SilverBan® on all Exposed Wood Surfaces

**ARM**



w	outside d	h	sw	seat sd	sh	seat to top of back	arm height	weight lbs.	cubic feet
2.25	21.25	8.75	n/a	n/a	n/a	n/a	25.25	10	n/a

**OPTIONS**

Metal Arms	Wood Arms and Arm Caps	Leg	Arm/Leg Finish (if applicable)	Seat Back	Fabric 1
<b>Standard</b> X9 No Selection of Option	<b>Standard</b> X9 No Selection of Option	<b>Standard</b> C8 Wood Leg	<b>Selection Required</b> For EIZ, FIA, FIB and C8 Options	<b>Standard</b> X9 No Selection of Option	<b>Selection Required</b>
With Black Poly Arm Cap E1W Left Side Facing \$283 E1X Right Side Facing \$283 E1Y Pair of Arms, Left and Right \$566	Wood (specify finish) E1Z Left Side Facing \$191 F1A Right Side Facing \$191 F1B Pair of Arms, Left and Right \$371  Arm Caps A4 Poly (black) \$102 each	<b>D1E</b> Brushed Aluminum Metal Leg	See page 9 for full list of finish options	<b>L4</b> Back Bump Guard \$178	Fabric: Grade, Vendor, Pattern, Color  NOTE: For multiple fabric applications see page 14 for information and pricing

**HOW TO ORDER**

SPECIFY: Arms and arm caps | legs | wood finish (if applicable) | seat back | textile pattern and color. See pages 5-14 for information and options on moisture barrier, CAL133, upholstery applications, a complete offering of finishes and ordering details.

**MODEL NUMBER**

5110-60I

Metal Arms	Wood Arms and Arm Caps	Leg	Arm/Leg Finish (if applicable)	Seat Back	Fabric 1
X9	E1Z - A4	C8	MNW	L4	Grade 5, Momentum, Row, Breeze

**BASIL BENCH MODULAR STANDARD FEATURES**

- Ganging Devices
- Armless
- Clean-Thru Design
- Upholstered Seat and Sides
- Tight Cushion
- European Beech Legs
- Euroluxe® with SilverBan® on all Exposed Wood Surfaces
- Non-Marring Adjustable Glides
- NOTE: Floor Plan Required for any Ganging Configurations

**30° INSIDE WEDGE BENCH**



w	outside			sw	seat			seat to top of back	arm height	weight lbs.	cubic feet
	d	h			sd	sh					
35	29	18		n/a	n/a	n/a		n/a	n/a	47	16

model	yds com (54")	sq ft col	com 1	col 2	3	4	5	6	7	8	9	10	11	12	13	14	15	L1	L2	L3
5110-B30I	2	n/a	958	996	1,024	1,071	1,165	1,259	1,353	1,447	1,541	1,635	1,729	1,823	1,917	2,011	2,105	1,284	1,394	1,530

**30° OUTSIDE WEDGE BENCH**



w	outside			sw	seat			seat to top of back	arm height	weight lbs.	cubic feet
	d	h			sd	sh					
35	29	18		n/a	n/a	n/a		n/a	n/a	47	16

model	yds com (54")	sq ft col	com 1	col 2	3	4	5	6	7	8	9	10	11	12	13	14	15	L1	L2	L3
5110-B30O	2	n/a	958	996	1,024	1,071	1,165	1,259	1,353	1,447	1,541	1,635	1,729	1,823	1,917	2,011	2,105	1,284	1,394	1,530

**60° INSIDE WEDGE BENCH**

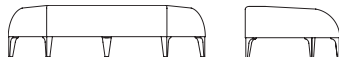

w	outside			sw	seat			seat to top of back	arm height	weight lbs.	cubic feet
	d	h			sd	sh					
69	33	18		n/a	n/a	n/a		n/a	n/a	75	35

model	yds com (54")	sq ft col	com 1	col 2	3	4	5	6	7	8	9	10	11	12	13	14	15	L1	L2	L3
5110-B60I	3	n/a	1,470	1,526	1,569	1,639	1,780	1,921	2,062	2,204	2,345	2,486	2,627	2,768	2,909	3,050	3,191	1,945	2,110	2,315

**60° OUTSIDE WEDGE BENCH**

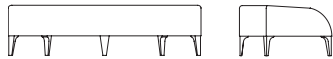

w	outside			sw	seat			seat to top of back	arm height	weight lbs.	cubic feet
	d	h			sd	sh					
69	33	18		n/a	n/a	n/a		n/a	n/a	75	34

model	yds com (54")	sq ft col	com 1	col 2	3	4	5	6	7	8	9	10	11	12	13	14	15	L1	L2	L3
5110-B60O	3.25	n/a	1,476	1,537	1,583	1,659	1,812	1,965	2,118	2,271	2,424	2,576	2,729	2,882	3,035	3,188	3,340	1,988	2,167	2,389

**90° INSIDE CORNER BENCH**



w	outside			sw	seat			seat to top of back	arm height	weight lbs.	cubic feet
	d	h			sd	sh					
59	29.5	18		n/a	n/a	n/a		n/a	n/a	67	23

model	yds com (54")	sq ft col	com 1	col 2	3	4	5	6	7	8	9	10	11	12	13	14	15	L1	L2	L3
5110-B90I	2.5	n/a	1,174	1,221	1,256	1,315	1,433	1,550	1,668	1,785	1,903	2,020	2,138	2,256	2,373	2,491	2,608	1,575	1,712	1,883

**90° OUTSIDE CORNER BENCH**



w	outside			sw	seat			seat to top of back	arm height	weight lbs.	cubic feet
	d	h			sd	sh					
59	29.5	18		n/a	n/a	n/a		n/a	n/a	67	23

model	yds com (54")	sq ft col	com 1	col 2	3	4	5	6	7	8	9	10	11	12	13	14	15	L1	L2	L3
5110-B90O	2.5	n/a	1,174	1,221	1,256	1,315	1,433	1,550	1,668	1,785	1,903	2,020	2,138	2,256	2,373	2,491	2,608	1,575	1,712	1,883

**OPTIONS**

Leg	Arm/Leg Finish (if applicable)	Fabric 1
Standard C8 Wood Leg	Selection Required For C8 Option	Selection Required
DIE Brushed Aluminum Metal Leg	See page 9 for full list of finish options	Fabric: Grade, Vendor, Pattern, Color  NOTE: For multiple fabric applications see page 14 for information and pricing

**HOW TO ORDER**

SPECIFY: Legs | wood finish (if applicable) | textile pattern and color. See pages 5-14 for information and options on moisture barrier, CAL133, upholstery applications, a complete offering of finishes and ordering details.

MODEL NUMBER		
5110-B30I		
Leg	Arm/Leg Finish (if applicable)	Fabric 1
C8	MNW	Grade 5, Momentum, Row, Breeze

**BASIL END TABLE STANDARD FEATURES**

- Some Field Installation required
- Ganging Devices
- European Beech Legs
- Top Options - Beech Veneer or HPL with Self Edge
- Eurolux® with SilverBan® on all Exposed Wood Surfaces
- Non-Marring Adjustable Glides
- NOTE: Floor Plan Required for any Ganging Configurations

**LEFT STRAIGHT END TABLE**

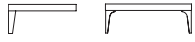

model	w	d	h	wt	cu ft	list
5110-E-LT	21	26.5	9	30	20	\$ 953

**RIGHT STRAIGHT END TABLE**



model	w	d	h	wt	cu ft	list
5110-E-RT	21	26.5	9	30	20	\$ 953

**30° LEFT INSIDE WEDGE END TABLE**



model	w	d	h	wt	cu ft	list
5110-30I-LT	34.75	25.75	9	32	26	\$ 1,190

**30° LEFT OUTSIDE WEDGE END TABLE**



model	w	d	h	wt	cu ft	list
5110-30O-LT	34.75	25.75	9	32	26	\$ 1,190

**30° RIGHT INSIDE WEDGE END TABLE**



model	w	d	h	wt	cu ft	list
5110-30I-RT	34.75	25.75	9	32	26	\$ 1,190

**30° RIGHT OUTSIDE WEDGE END TABLE**



model	w	d	h	wt	cu ft	list
5110-30O-RT	34.75	25.75	9	32	26	\$ 1,190

**OPTIONS**

Leg	Top
Standard C8 Wood Leg (specify finish)	Selection Required
DIE Brushed Aluminum Metal Leg	Veneer (Matching Edge) HPL (Self Edge)  See pages 9-10 for full list of finish and HPL options

**HOW TO ORDER**

SPECIFY: Legs | wood finish (if applicable) | Top - Veneer or HPL. See pages 5-14 for a complete offering of finishes and ordering details.

**MODEL NUMBER**

5110-E-LT

Leg	Top
DIE	MNW

**BASIL CORNER TABLE STANDARD FEATURES**

- Some Field Installation required
- Ganging Devices
- European Beech Legs
- Top Options - Beech Veneer or HPL with Self Edge
- Euroluxe® with SilverBan® on all Exposed Wood Surfaces
- Non-Marring Adjustable Glides
- NOTE: Floor Plan Required for any Ganging Configurations

**90° INSIDE CORNER TABLE**

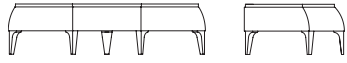

w	outside d	h	sw	seat sd	sh	seat to top of back	arm height	weight lbs.	cubic feet
59	29.5	15	n/a	n/a	n/a	n/a	n/a	72	44

model	yds com (54")	sq ft col	com 1	col 2	3	4	5	6	7	8	9	10	11	12	13	14	15	L1	L2	L3
5110-90I	2	n/a	1,462	1,500	1,528	1,575	1,669	1,763	1,857	1,951	2,045	2,139	2,233	2,327	2,421	2,515	2,609	1,788	1,898	2,034

**90° OUTSIDE CORNER TABLE**

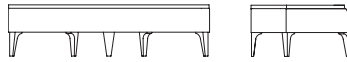

w	outside d	h	sw	seat sd	sh	seat to top of back	arm height	weight lbs.	cubic feet
59	29.5	15	n/a	n/a	n/a	n/a	n/a	72	44

model	yds com (54")	sq ft col	com 1	col 2	3	4	5	6	7	8	9	10	11	12	13	14	15	L1	L2	L3
5110-90O	2	n/a	1,462	1,500	1,528	1,575	1,669	1,763	1,857	1,951	2,045	2,139	2,233	2,327	2,421	2,515	2,609	1,788	1,898	2,034

**OPTIONS**

Leg	Top	Fabric 1
<b>Standard</b> C8 Wood Leg (specify finish)	<b>Selection Required</b>	<b>Selection Required</b>
<b>DIE</b> Brushed Aluminum Metal Leg	Veneer (Matching Edge) HPL (Self Edge)  See pages 9-10 for full list of finish and HPL options	Fabric: Grade, Vendor, Pattern, Color  NOTE: For multiple fabric applications see page 14 for information and pricing

**HOW TO ORDER**

SPECIFY: Legs | wood finish (if applicable) | Top - Veneer or HPL | textile pattern and color. See pages 5-14 for information and options on moisture barrier, CAL133, upholstery applications, a complete offering of finishes and ordering details.

**MODEL NUMBER**

5110-90I

Leg	Top	Fabric 1
<b>DIE</b>	<b>MNW</b>	<b>Grade 5, Momentum, Row, Breeze</b>

**BASIL GANGING TABLE STANDARD FEATURES**

- Some Field Installation required
- Ganging Devices
- Top Options - Beech Veneer or HPL with Self Edge
- Eurolux® with SilverBan® on all Exposed Wood Surfaces
- NOTE: Floor Plan Required for any Ganging Configurations

**STRAIGHT MIDDLE TABLE**

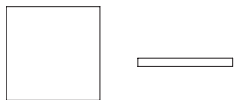

model	w	d	h	wt	cu ft	list
5110-M	21	26.5	2	30	20	\$ 529

**30° INSIDE/OUTSIDE WEDGE MIDDLE TABLE**



model	w	d	h	wt	cu ft	list
5110-30-I-O	34.75	25.75	2	30	26	\$ 953

**60° INSIDE/OUTSIDE WEDGE MIDDLE TABLE**



model	w	d	h	wt	cu ft	list
5110-60	47.5	23	2	47	34	\$ 973

**OPTIONS**

**Top**

**Selection Required**

Veneer (Matching Edge)  
HPL (Self Edge)

See pages 9-10 for full list of finish and HPL options

**HOW TO ORDER**

SPECIFY: Top - Veneer or HPL. See pages 5-14 for a complete offering of finishes and ordering details.

**MODEL NUMBER**

5110-M

**Top**

MNW